

# External documentation

---

- [Apache HTTP Server Version 2.4 Documentation](#)

## **Tip**

Whenever searching for Apache related documentation *a/ways* include “2.4” in your query: Configuration file syntax changed considerably with respect to Apache version 2.2.

# URI to filesystem mapping

---



# URI to filesystem mapping

---

<https://www.my.org/sub/foo.html>



# URI to filesystem mapping

---

<https://www.my.org/sub/foo.html>

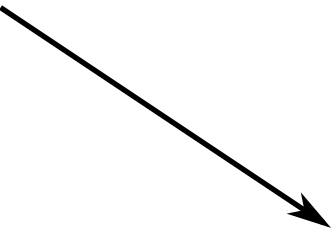

**Webserver's filesystem**

# URI to filesystem mapping

---

<https://www.my.org/sub/foo.html>

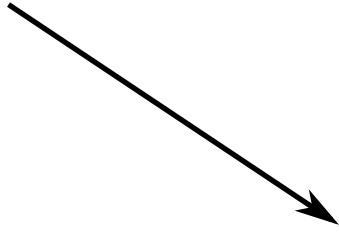

**Webserver's filesystem**

**DocumentRoot** `/var/www/html`

# URI to filesystem mapping

---

<https://www.my.org/sub/foo.html>

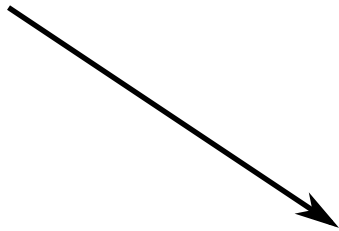

**Webserver's filesystem**

**DocumentRoot** `/var/www/html`

`/var/www/html` `/sub/foo.html`

# Virtual hosting

---

- One physical host system
- Serving multiple sites e.g.:
  - `https://www.foo.org`
  - `https://www.second.org`

# Implementing virtual hosting

---

1. Port based virtual hosting
2. IP based virtual hosting
3. Name based virtual hosting

Typically using **S**erver **N**ame **I**ndication (SNI)



# IP based virtual hosting

---



<https://www.second.org>

# IP based virtual hosting

---



DNS

<https://www.second.org>

# IP based virtual hosting

---



# IP based virtual hosting

---



<https://www.second.org>

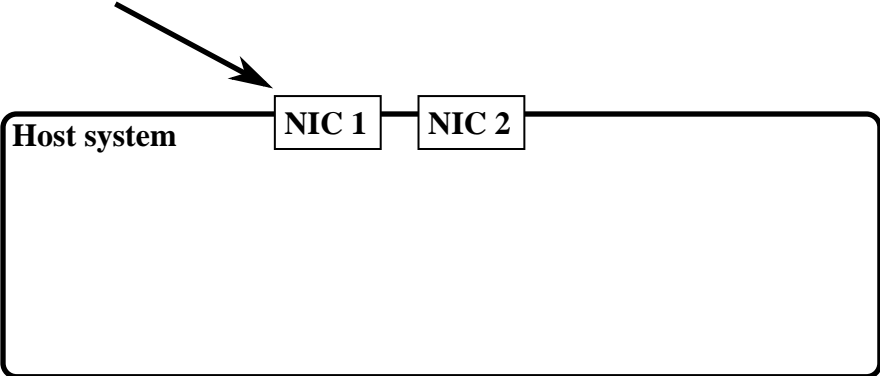

# IP based virtual hosting

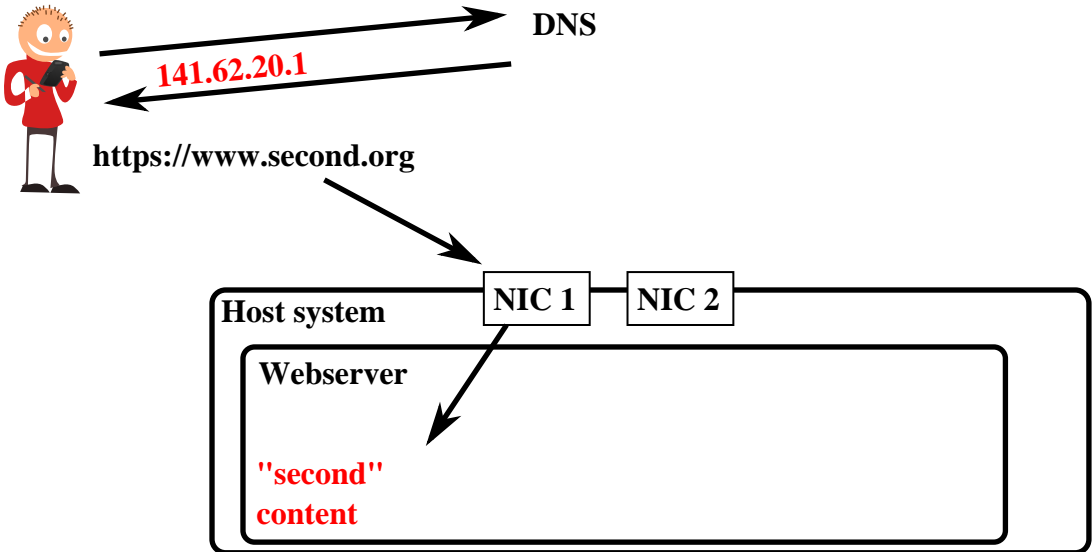

# IP based virtual hosting

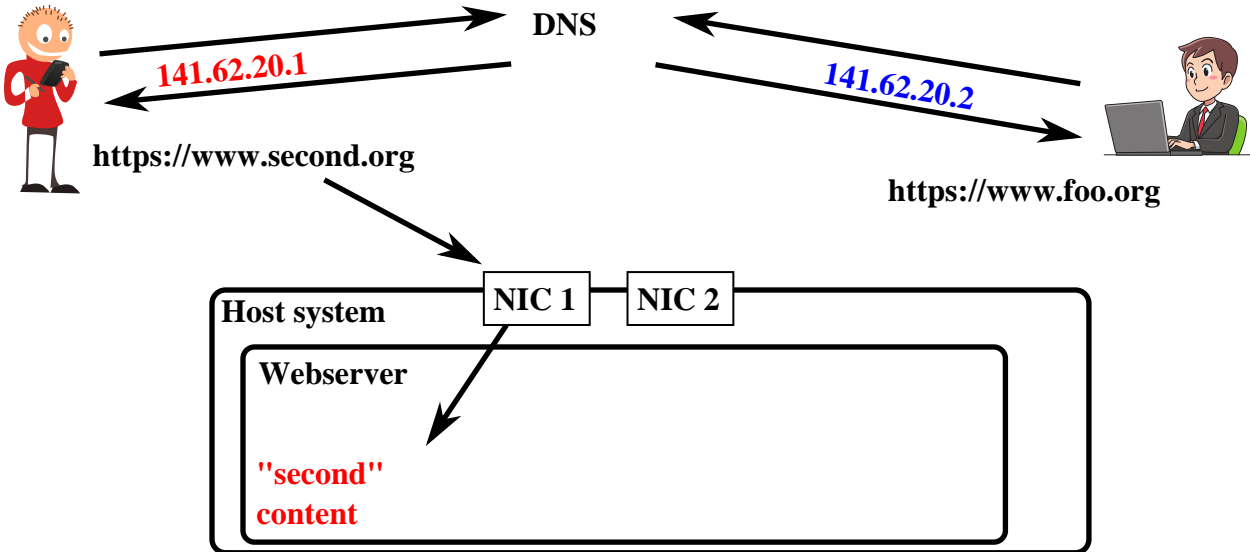

# IP based virtual hosting

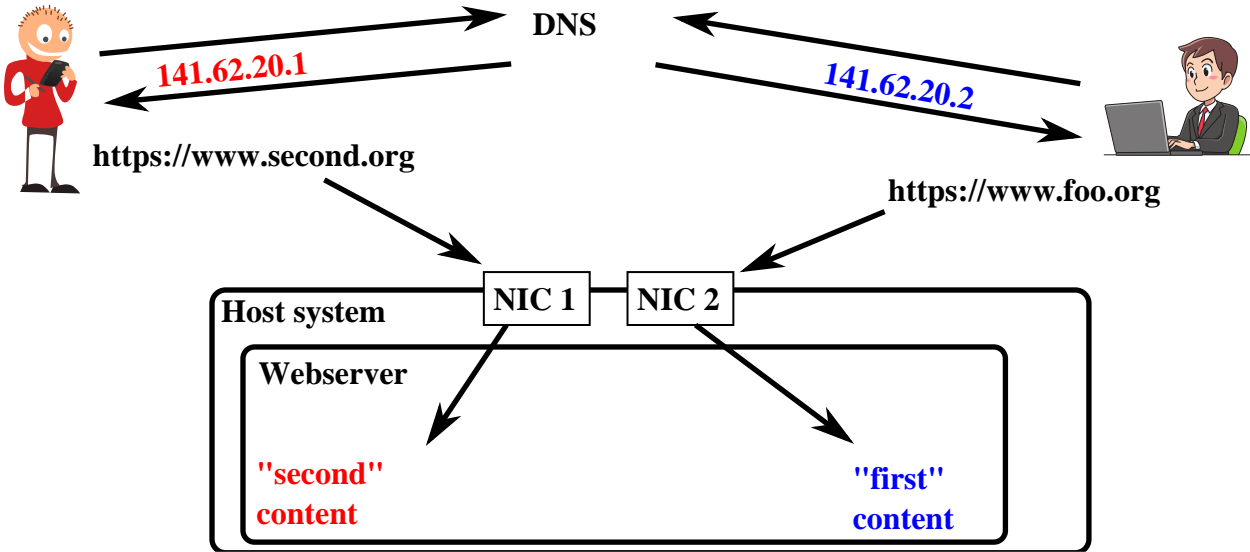

# IP based virtual hosting

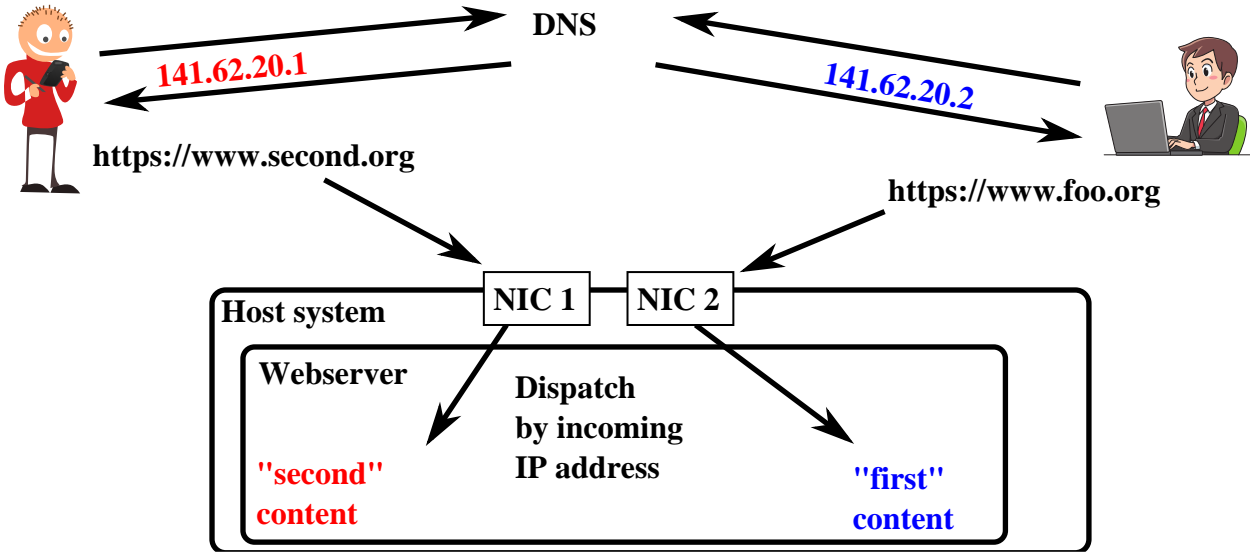



# IP based, pros / cons

---

- Host system: One IP per site to serve
- Pro: TLS handshake without SNI.  
Supporting older clients.
- Downside:
  - IP address waste
  - Host system NIC configuration required

# Name based virtual hosting

---



<https://www.second.org>

# Name based virtual hosting

---



DNS

*<https://www.second.org>*

# Name based virtual hosting

---

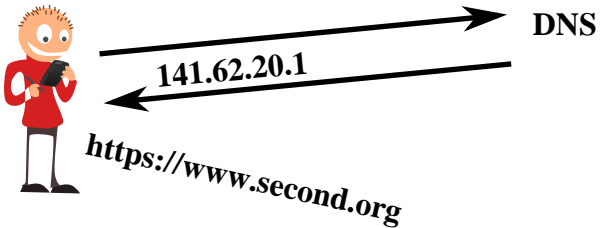

# Name based virtual hosting

---

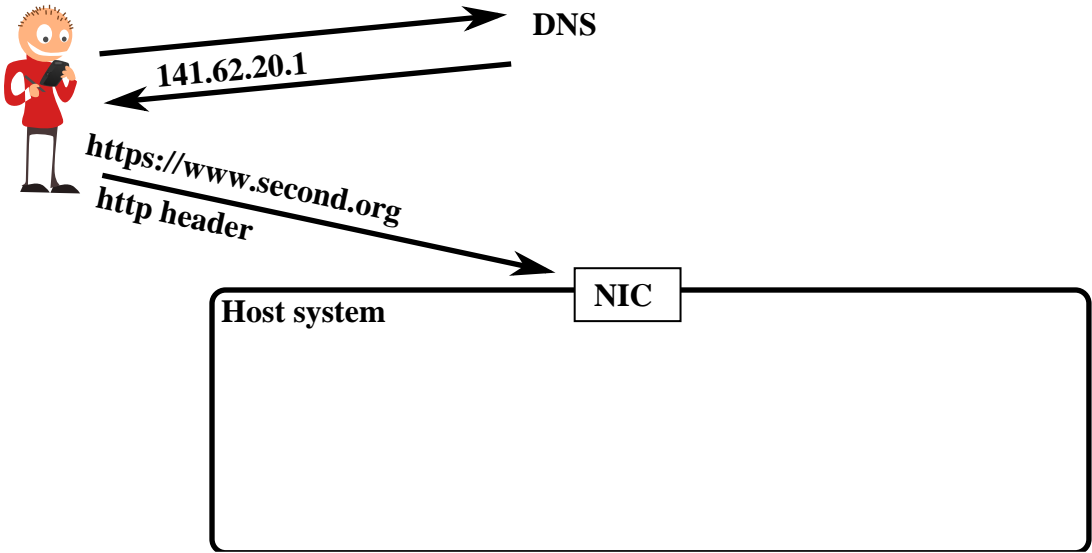

# Name based virtual hosting

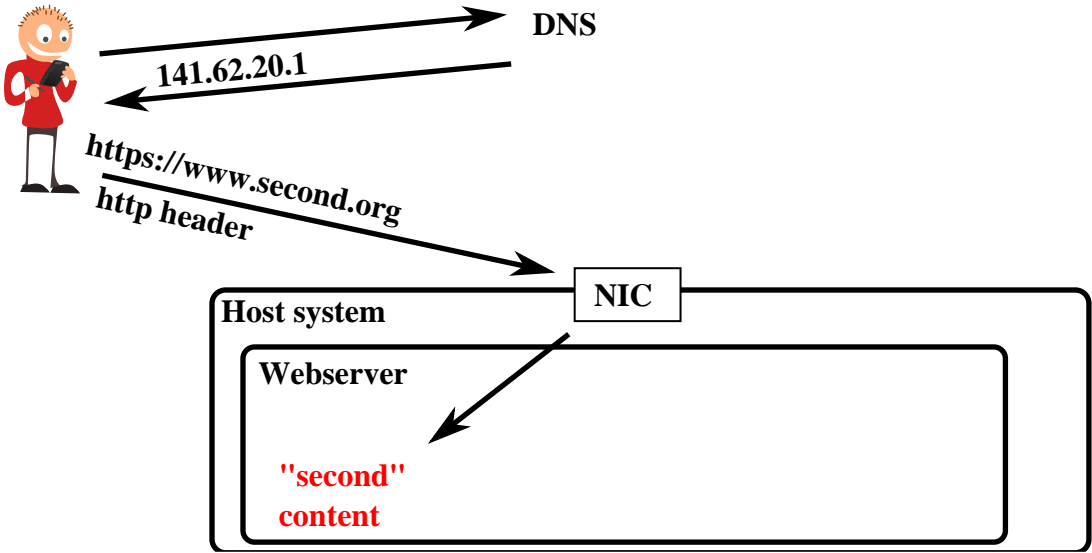

# Name based virtual hosting

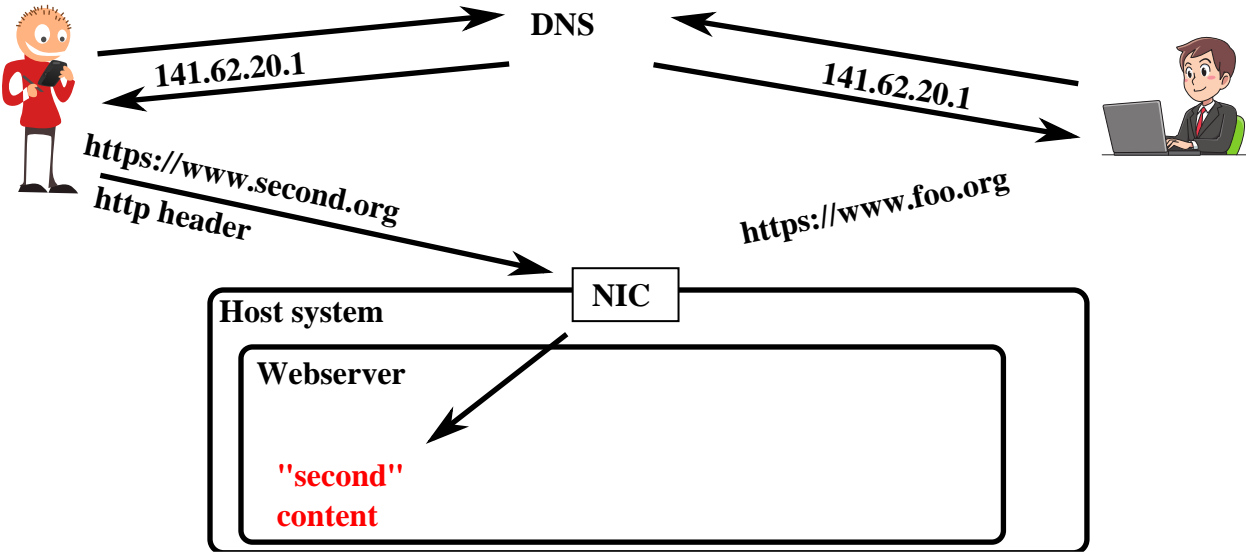

# Name based virtual hosting

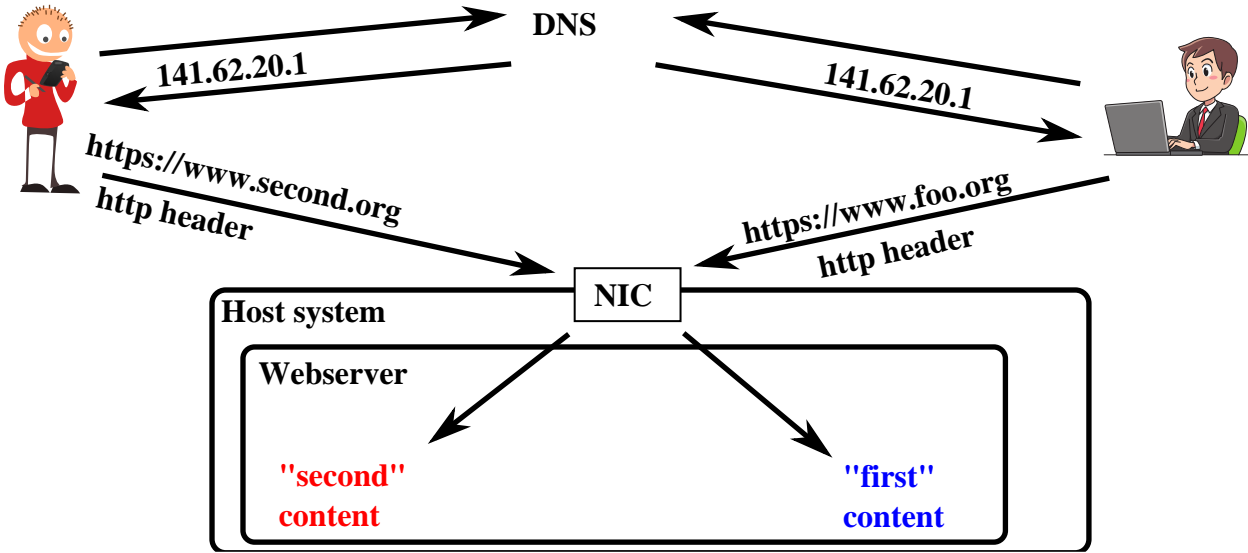



# Name based virtual hosting

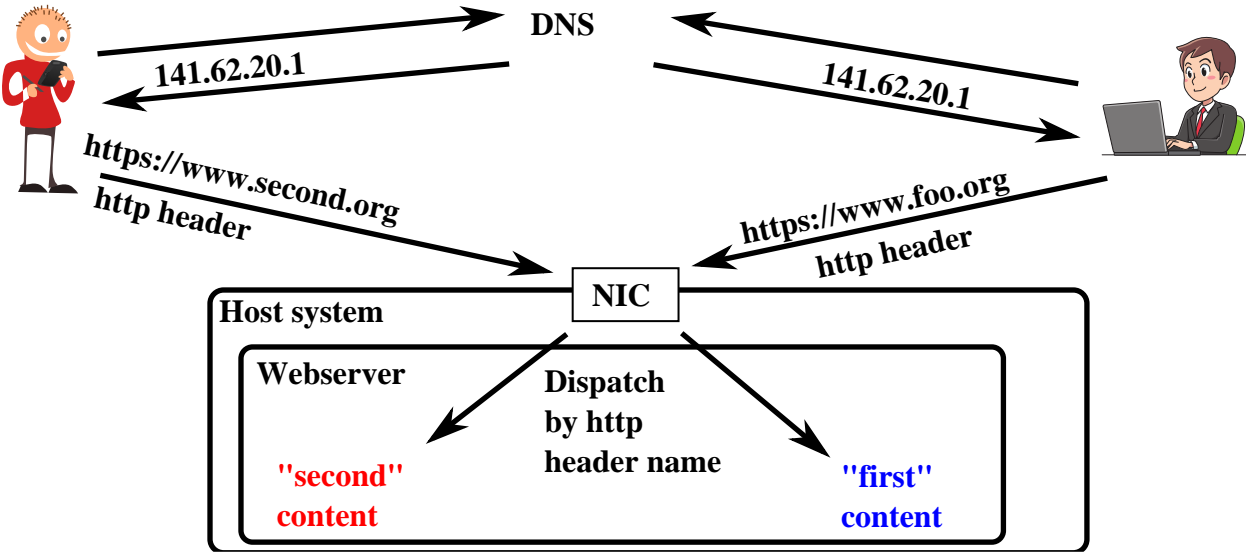

# Name based, pros / cons

---

- Host system: Common IP address
- Pro
  - No IP address waste
  - No Host system NIC configuration required
- Cons: Excluding older non SNI supporting clients.

(Internet Explorer on Windows XP, Android below V. 2.3)

- SNI allows for eavesdropping requested site's name.

# LDAP backed authentication

---

`https://www.my.org`

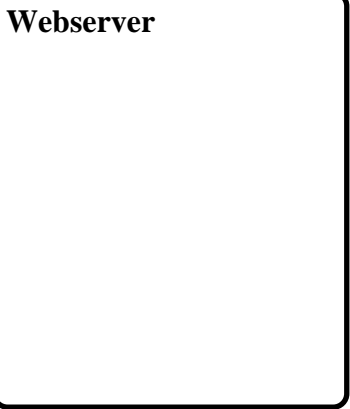

# LDAP backed authentication

---

https://www.my.org

uid=diana

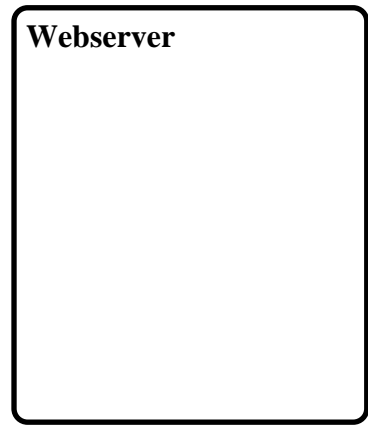

# LDAP backed authentication

https://www.my.org

uid=diana



LDAP

bind

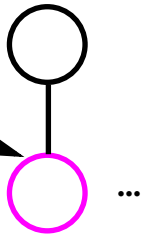

objectClass: posixAccount  
uid:diana  
userPassword: ...

# LDAP backed authentication

https://www.my.org

uid=diana



LDAP

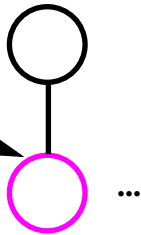

bind

success or

failure

objectClass: posixAccount  
uid:diana  
userPassword: ...

# LDAP backed authentication

https://www.my.org

uid=diana

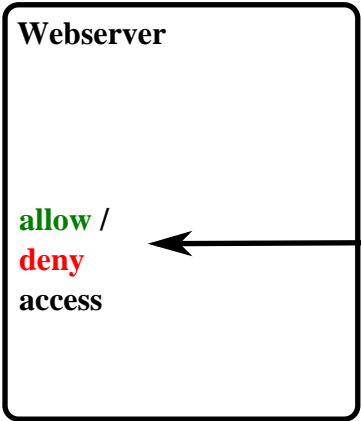

LDAP



bind

success or

failure

...

objectClass: posixAccount  
uid:diana  
userPassword: ...

# PHP FPM server

---





# PHP FPM server

---

<https://www.my.org/index.php>

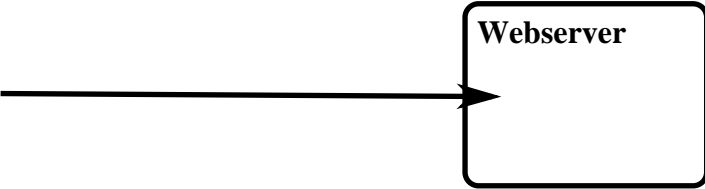

# PHP FPM server

---

<https://www.my.org/index.php>

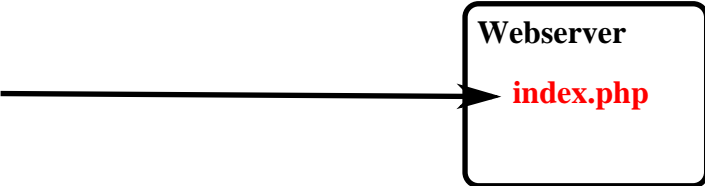

# PHP FPM server

---

<https://www.my.org/index.php>

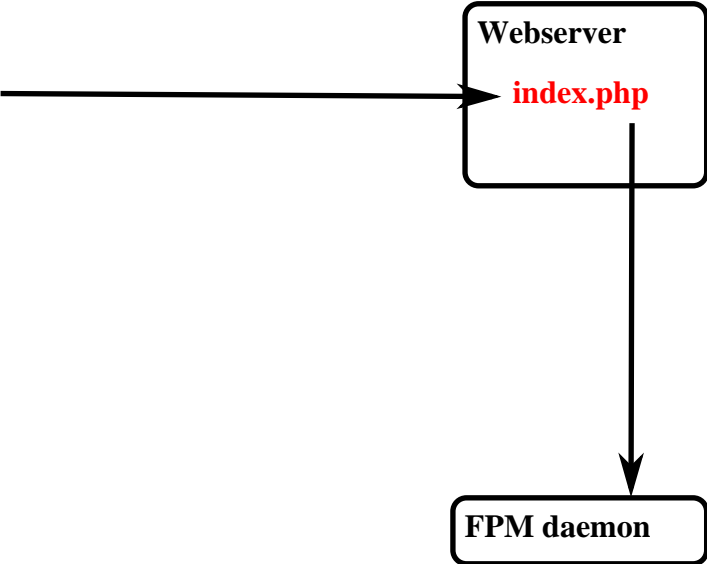

# PHP FPM server

---

<https://www.my.org/index.php>

